

# MAGNETIC DRILLING MACHINE

## OPERATION MANUAL



- **HF-35(D950)**  
1 Speed Drilling System (N)
- **HF-30A(D9505)**  
Semi Auto Feed Drilling System(N)
- **HF-750(D9507)**  
4 Speed Drilling System



### **Warning:**

For tools equipped with over load protection, when motor has shut down off due to over load, always run machine with no load for at least 3 minutes to reduce temperature before returning to operation to avoid burn out of the motor.

*Edition No* : MBD-001

*Date of Issue* : 07/2022

# WARNING

## General Machinery Safety Instructions

---

Machinery House  
requires you to read this entire Manual before using this machine.

- 1. Read the entire Manual before starting machinery.** Machinery may cause serious injury if not correctly used.
- 2. Always use correct hearing protection when operating machinery.** Machinery noise may cause permanent hearing damage.
- 3. Machinery must never be used when tired, or under the influence of drugs or alcohol.** When running machinery you must be alert at all times.
- 4. Wear correct Clothing.** At all times remove all loose clothing, necklaces, rings, jewelry, etc. Long hair must be contained in a hair net. Non-slip protective footwear must be worn.
- 5. Always wear correct respirators around fumes or dust when operating machinery.** Machinery fumes & dust can cause serious respiratory illness. Dust extractors must be used where applicable.
- 6. Always wear correct safety glasses.** When machining you must use the correct eye protection to prevent injuring your eyes.
- 7. Keep work clean and make sure you have good lighting.** Cluttered and dark shadows may cause accidents.
- 8. Personnel must be properly trained or well supervised when operating machinery.** Make sure you have clear and safe understanding of the machine you are operating.
- 9. Keep children and visitors away.** Make sure children and visitors are at a safe distance for you work area.
- 10. Keep your workshop childproof.** Use padlocks, Turn off master power switches and remove start switch keys.
- 11. Never leave machine unattended.** Turn power off and wait till machine has come to a complete stop before leaving the machine unattended.
- 12. Make a safe working environment.** Do not use machine in a damp, wet area, or where flammable or noxious fumes may exist.
- 13. Disconnect main power before service machine.** Make sure power switch is in the off position before re-connecting.
- 14. Use correct amperage extension cords.** Undersized extension cords overheat and lose power. Replace extension cords if they become damaged.
- 15. Keep machine well maintained.** Keep blades sharp and clean for best and safest performance. Follow instructions when lubricating and changing accessories.
- 16. Keep machine well guarded.** Make sure guards on machine are in place and are all working correctly.
- 17. Do not overreach.** Keep proper footing and balance at all times.
- 18. Secure workpiece.** Use clamps or a vice to hold the workpiece where practical. Keeping the workpiece secure will free up your hand to operate the machine and will protect hand from injury.
- 19. Check machine over before operating.** Check machine for damaged parts, loose bolts, Keys and wrenches left on machine and any other conditions that may effect the machines operation. Repair and replace damaged parts.
- 20. Use recommended accessories.** Refer to instruction manual or ask correct service officer when using accessories. The use of improper accessories may cause the risk of injury.
- 21. Do not force machinery.** Work at the speed and capacity at which the machine or accessory was designed.
- 22. Use correct lifting practice.** Always use the correct lifting methods when using machinery. Incorrect lifting methods can cause serious injury.
- 23. Lock mobile bases.** Make sure any mobile bases are locked before using machine.
- 24. Allergic reactions.** Certain metal shavings and cutting fluids may cause an allergic reaction in people and animals, especially when cutting as the fumes can be inhaled. Make sure you know what type of metal and cutting fluid you will be exposed to and how to avoid contamination.
- 25. Call for help.** If at any time you experience difficulties, stop the machine and call you nearest branch service department for help.

# WARNING

## Magnetic Drilling Machine Safety Instructions

---

Machinery House  
requires you to read this entire Manual before using this machine.

- 1. Maintenance.** Make sure the Magnetic Drill is turned off and disconnect from the main power supply and make sure all moving parts have come to a complete stop before any inspection, adjustment or maintenance is carried out.
- 2. Magnetic Drill Condition.** Magnetic Drill must be maintained for a proper working condition. Never operate a Magnetic Drill that has damaged or worn parts. Scheduled routine maintenance should be performed on a scheduled basis.
- 3. Leaving a Magnetic Drill Unattended.** Always turn the Magnetic Drill off and make sure all moving parts have come to a complete stop before leaving the Magnetic Drill. Do not leave a Magnetic Drill running unattended for any reason.
- 4. Avoiding Entanglement.** Remove loose clothing, belts, or jewelry items. Tie up long hair and use the correct hair nets to avoid any entanglement with the Magnetic Drill spindle or moving parts.
- 5. Chuck key & wrench safety.** Always remove chuck keys, wrenches and any service tools immediately after use. Chuck keys left in the chuck can cause serious injury.
- 6. Understand the machines controls.** Make sure you understand the use and operation of all controls.
- 7. Magnetic Drill bit selection.** Always use the correct Drill bit for the job you are Drilling.
- 8. Secure the Drill Bit.** Make sure the drill bit is inserted correctly into the chuck before operation.
- 9. Cutting Tool inspection.** Inspect Drill for sharpness, chips, or cracks before use. Replace any cutting tools immediately if dull, chipped or cracked. Handle new cutting tools with care. Cutting edges are very sharp and can cause lacerations.
- 10. Reversing the spindle.** Make sure the spindle has come to a complete stop before changing the direction of the spindle.
- 11. Stopping the spindle.** Do not slow or stop the spindle by using your hand.
- 12. Speed selection.** Select the appropriate speed for the type of work, material, and tool bit. Allow the Drill to reach full speed before beginning a cut.
- 13. Clearing chips.** Always use a brush to clear chips. Never clear chips when the drill is running.
- 14. Power outage.** In the event of a power failure during use of the drill, turn off all switches to avoid possible sudden start up once power is restored.
- 15. Clean work area.** Keep the area around the drill clean from oil, tools, chips.
- 16. Surface/Magnetic Clamping.** Before clamping the drill, make sure the surface is clear of any objects (tools, scraps, off-cuts etc.) Do not clamp the drill to a surface that does not have a flat surface.
- 17. Guarding.** All Magnetic drill guards should be in place before any operation.
- 18. Eye and hand protection.** A face shield with safety glasses is recommended. Always keep hands and fingers away from the drill bit. Never hold a workpiece in your hand while drilling.
- 19. Drill operation.** Never start the drill with the drill bit pressed against the workpiece. Feed the drill evenly into the workpiece. Back the drill out of deep holes. Turn the machine off and clear chips and scrap pieces with a brush.
- 21. Pacemaker Protection.** Please note: no person with a pacemaker should be closer than 6 foot or 1.828 metres to an Electromagnetic machine or anything that has an electrical field.
  1. Strong electromagnetic fields can cause electromagnetic interference.
  2. EMI can stop the pacemaker from sensing your heart's rhythm.
- 20. Call for help.** If at any time you experience difficulties, stop the machine and call you nearest branch service department for help.

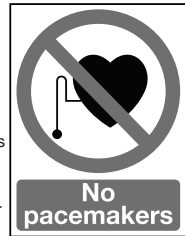

# PLANT SAFETY PROGRAM

## NEW MACHINERY HAZARD IDENTIFICATION, ASSESSMENT & CONTROL

### Magnetic Drilling Machine

Developed in Co-operation Between A.W.I.S.A and Australia Chamber of Manufactures  
 This program is based upon the Safe Work Australia, Code of Practice - Managing Risks of Plant in the Workplace ( WHSA 2011 No10 )

Item No.	Hazard Identification	Hazard Assessment	Risk Control Strategies <small>(Recommended for Purchase / Buyer / User)</small>
A	ENTANGLEMENT	HIGH	Eliminate, avoid loose clothing / Long hair etc.
B	CRUSHING	LOW	Secure Magnetic Drill to workpiece. Keep hands clear of Magnets when clamping.
C	CUTTING, STABBING, PUNCTURING.	MEDIUM	Isolate power to machine prior to any checks or maintenance being carried out. Do not adjust or clean until the machine has fully stopped.
D	SHEARING	MEDIUM	Isolate power to machine when changing speeds or maintenance is being carried out. Make sure all guards are secured shut when machine is on.
F	STRIKING	MEDIUM	Ensure workpieces are tightly secured on machine. Wear safety glasses. Ensure correct spindle direction when drilling.
H	ELECTRICAL	MEDIUM	Electrical enclosures should only be opened with a tool that is not kept with the machine. Never clean or dust machine when power is on.
M	HIGH TEMPERATURE	LOW	Wear appropriate protective clothing to prevent hot swarf.
O	OTHER HAZARDS, NOISE.	LOW	Wear hearing protection as required. Pacemaker Protection.. Please note: no person with a pacemaker should be closer than 6 foot or 1.828 metres to an Electromagnetic drill or anything that has an electrical field. 1. Strong electromagnetic fields can cause electromagnetic interference. 2. EMI can stop the pacemaker from sensing your heart's rhythm.

Plant Safety Program to be read in conjunction with manufactures instructions



www.machineryhouse.com.au



www.machineryhouse.co.nz

Authorised and signed by:

Safety officer: .....

Manager: .....

Revised Date: 8th July 2014

# 1 Speed Drilling System (N)

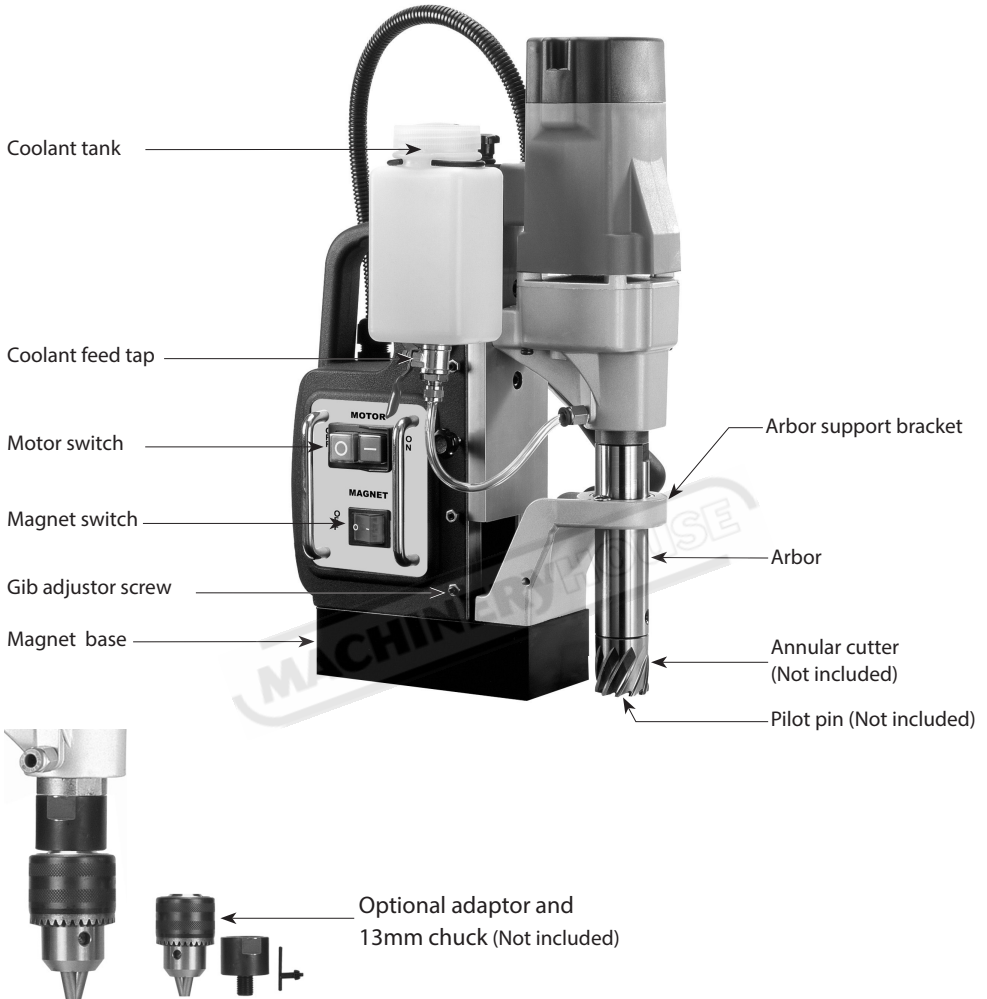

MODEL	HF-35(D950)	
POWER INPUT	1100 W	
VOLTAGE	See machine nameplate	
NO / FULL LOAD min <sup>-1</sup>	550 / 330	
CAPACITY	DIA. x DEPTH OF CUT	35 mm x 50 mm
	DIA. x DEPTH OF TWIST DRILL BIT	13 mm x 110 mm
	DIA. x DEPTH OF TAPS	N/A
MAGNETIC ADHESION	15,000 N	
NET WEIGHT	12.6 kg (27.72 lb)	

## STANDARD ACCESSORIES

- \* WRENCH M8
- \* HEX. KEY M2.5
- \* HEX. KEY M4
- \* CHIP GUARD KIT
- \* COOLANT TANK KIT
- \* SAFETY STRAP

## OPTIONAL ACCESSORY

- \* CHUCK ADAPTOR
- \* 13MM CHUCK & KEY

## Semi Auto Feed Drilling System (N)

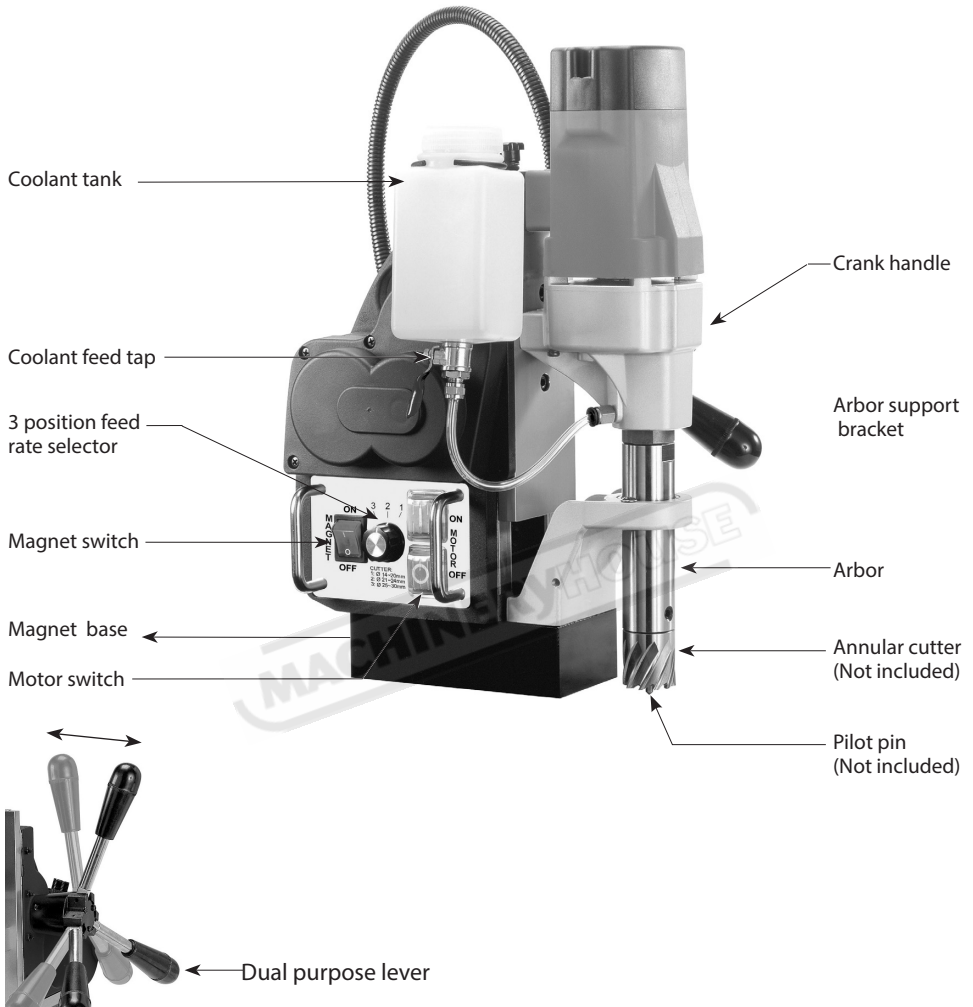

MODEL	HF-30A(D9505)	<b>STANDARD ACCESSORIES</b>	
POWER INPUT	1100 W		
VOLTAGE	See machine nameplate		
NO / FULL LOAD min <sup>-1</sup>	550 / 330		
CAPACITY	DIA. x DEPTH OF CUT ( HAND FEED)		35 mm x 50 mm
	DIA. x DEPTH OF CUT ( AUTO FEED)		30 mm x 45 mm
	DIA. x DEPTH OF TWIST DRILL BIT ( HAND FEED ONLY)		13 mm x 110 mm
	DIA. x DEPTH OF TAPS		N/A
MAGNETIC ADHESION	15,000 N		
NET WEIGHT	15.90 kg (35.05 lb)		

# 4 Speed Drilling System

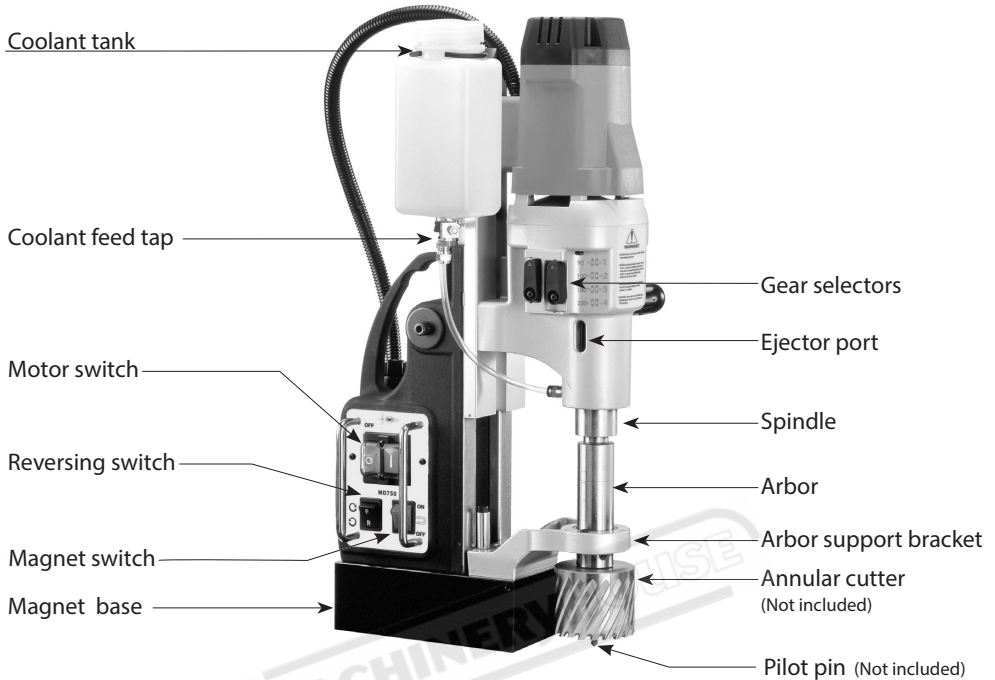

MT3 Tapping adaptor and Tapping unit (Not included)



MT3 Twist drill bit (Not included)



MT3 Chuck adaptor and Chuck (Not included)

MODEL	HF-750(D9507)	
POWER INPUT	1700 W (110 V), 2000 W (220 V)	
VOLTAGE	See machine nameplate	
NO/FULL LOAD min <sup>-1</sup>	SPEED 1	150 / 90
	SPEED 2	200 / 120
	SPEED 3	300 / 180
	SPEED 4	380 / 230
	DIA. x DEPTH OF CUT ( HAND FEED)	
CAPACITY	DIA. x DEPTH OF MT3 TWIST DRILL BIT	
	DIA. x DEPTH OF MT3 CHUCK ADAPTOR WITH TWIST DRILL BIT	
	DIA. x DEPTH OF TAPS	
MAGNETIC ADHESION	32,000 N	
NET WEIGHT	24.40 kg ( 53.79 lb)	

### STANDARD ACCESSORIES

- \* WRENCH M8
- \* HEX. KEY M2.5
- \* HEX. KEY M4
- \* CHIP GUARD KIT
- \* COOLANT TANK KIT
- \* SAFETY STRAP
- \* DRIFT

### OPTIONAL ACCESSORY

- \* MT3 CHUCK ADAPTOR
- \* 16MM CHUCK & KEY
- \* MT3 TAPPING ADAPTOR
- \* TAPPING ATTACHMENT

# GENERAL POWER TOOL SAFETY WARNINGS



**WARNING** Read all safety warnings, instructions, illustrations and specifications provided with this power tool. Failure to follow all instructions listed below may result in electric shock, fire and/or serious injury.

**Save all warnings and instructions for future reference.**

The term "power tool" in the warnings refers to your mains-operated (corded) power tool or battery-operated (cordless) power tool.

## 1) WORK AREA SAFETY

- a. **Keep work area clean and well lit.** Cluttered or dark areas invite accidents.
- b. **Do not operate power tools in explosive atmospheres, such as in the presence of flammable liquids, gases or dust.** Power tools create sparks which may ignite the dust or fumes.
- c. **Keep children and bystanders away while operating a power tool.** Distractions can cause you to lose control.
- d. **Never leave the electric power tool unattended.** Only leave the machine when the tool in use has come to a complete standstill.

## 2) ELECTRICAL SAFETY

- a. **Power tool plugs must match the outlet. Never modify the plug in any way. Do not use any adapter plugs with earthed (grounded) power tools.** Unmodified plugs and matching outlets will reduce risk of electric shock.
- b. **Avoid body contact with earthed or grounded surfaces, such as pipes, radiators, ranges and refrigerators.** There is an increased risk of electric shock if your body is earthed or grounded.
- c. **Do not expose power tools to rain or wet conditions.** Water entering a power tool will increase the risk of electric shock.
- d. **Do not abuse the cord. Never use the cord for carrying, pulling or unplugging the power tool. Keep cord away from heat, oil, sharp edges or moving parts.** Damaged or entangled cords increase the risk of electric shock.
- e. **When operating a power tool outdoors, use an extension cord suitable for outdoor use.** Use of a cord suitable for outdoor use reduces the risk of electric shock.
- f. **If operating a power tool in a damp location is unavoidable, use a residual current device (RCD) protected supply.** Use of an RCD reduces the risk of electric shock.

## 3) PERSONAL SAFETY

- a. **Stay alert, watch what you are doing and use common sense when operating a power tool. Do not use a power tool while you are tired or under the influence of drugs, alcohol or medication.** A moment of inattention while operating power tools may result in serious personal injury.
- b. **Use personal protective equipment. Always wear eye protection.** Protective equipment such as a dust mask, non-skid safety shoes, hard hat or hearing protection used for appropriate conditions will reduce personal injuries.
- c. **Prevent unintentional starting. Ensure the switch is in the off-position before connecting to power source and/or battery pack, picking up or carrying the tool.** Carrying power tools with your finger on



the switch or energising power tools that have the switch on invites accidents.

- d. **Remove any adjusting key or wrench before turning the power tool on.** A wrench or a key left attached to a rotating part of the power tool may result in personal injury.
- e. **Do not overreach. Keep proper footing and balance at all times.** This enables better control of the power tool in unexpected situations.
- f. **Dress properly. Do not wear loose clothing or jewellery. Keep your hair and clothing away from moving parts.** Loose clothes, jewellery or long hair can be caught in moving parts.
- g. **If devices are provided for the connection of dust extraction and collection facilities, ensure these are connected and properly used.** Use of dust collection can reduce dust-related hazards.
- h. **Do not let familiarity gained from frequent use of tools allow you to become complacent and ignore tool safety principles.** A careless action can cause severe injury within a fraction of a second.

#### 4) POWER TOOL USE AND CARE

- a. **Do not force the power tool. Use the correct power tool for your application.** The correct power tool will do the job better and safer at the rate for which it was designed.
- b. **Do not use the power tool if the switch does not turn it on and off.** Any power tool that cannot be controlled with the switch is dangerous and must be repaired.
- c. **Disconnect the plug from the power source and/or remove the battery pack, if detachable, from the power tool before making any adjustments, changing accessories, or storing power tools.** Such preventive safety measures reduce the risk of starting the power tool accidentally.
- d. **Store idle power tools out of the reach of children and do not allow persons unfamiliar with the power tool or these instructions to operate the power tool.** Power tools are dangerous in the hands of untrained users.
- e. **Maintain power tools and accessories. Check for misalignment or binding of moving parts, breakage of parts and any other condition that may affect the power tool's operation. If damaged, have the power tool repaired before use.** Many accidents are caused by poorly maintained power tools.
- f. **Keep cutting tools sharp and clean.** Properly maintained cutting tools with sharp cutting edges are less likely to bind and are easier to control.
- g. **Use the power tool, accessories and tool bits etc. in accordance with these instructions, taking into account the working conditions and the work to be performed.** Use of the power tool for operations different from those intended could result in a hazardous situation.
- h. **Keep handles and grasping surfaces dry, clean and free from oil and grease.** Slippery handles and grasping surfaces do not allow for safe handling and control of the tool in unexpected situations.

#### 5) SERVICE

Have your power tool serviced by a qualified repair person using only identical replacement parts. This will ensure that the safety of the power tool is maintained.

## Symbols used in this manual

V.....volts

A.....amperes

Hz.....hertz

W.....watt

~.....alternating current

$n_0$ .....no load speed

$\text{min}^{-1}$ .....revolutions or reciprocation  
per minute



.....warning of general danger



...with electrical earth



.....read these instructions



.....always wear eye protection



.....always wear a dust mask.



.....always wear hearing protection



.....wear safety-approved hard hat



do not dispose of electric tools,  
accessories and packaging together  
with household waste material

## TERMINOLOGY USED IN THE MANUAL

- 1. Warning:** This term means that there is a risk of physical harm or death to the operator or people nearby.
- 2. Caution:** This term means that there is a risk of damage to the machine, cutting tool or other equipment.
- 3. Note:** These terms offer useful information relating to the operation of the machine or its maintenance.

## DRILL SAFETY WARNINGS

- a. The drill must be secured.** A drill that is not properly secured may move or tip over and may result in personal injury.
- b. The workpiece must be clamped or secured to the workpiece support. Do not drill pieces that are too small to be clamped securely.** Holding the workpiece by hand during operation may result in personal injury.
- c. Do not wear gloves.** Gloves may be entangled by the rotating parts or chips, leading to personal injury.
- d. Keep your hands out of the drilling area while the tool is running.** Contact with rotating parts or chips may result in personal injury.
- e. Make sure the accessory is rotating before feeding into the workpiece.** Otherwise the accessory may become jammed in the workpiece, causing unexpected movement of the workpiece and personal injury.
- f. When the accessory is jammed, stop applying downward pressure and switch off the tool. Investigate and take corrective actions to eliminate the cause of the jam.** Jamming can cause unexpected movement of the workpiece and personal injury.
- g. Avoid generating long chips by regularly interrupting downward pressure.** Sharp metal chips may cause entanglement and personal injuries.
- h. Never remove chips from the drilling area while the tool is running. To remove chips, move the accessory away from the workpiece, switch off the tool, and wait for the accessory to stop moving. Use tools such as a brush or hook to remove chips.** Contact with rotating parts or chips may result in

personal injury.

- i. **Accessories with speed ratings must be rated at least equal to the maximum speed marked on the power tool.** Accessories running faster than their rated speed can break and fly apart.
- j. **Always use the chip guard kit.**

## MAGNETIC DRILL SPECIFIC SAFETY WARNINGS AND CAUTIONS

- a. **Always use safety Strap.** Mounting can release.
- b. **WARNING: While operating, only hold the crank handles, not any other part of the machine.** Placing the hand on the machine may result in an electric shock in the event of a voltage leak or if the machine cuts its own power supply cable.
- c. **Always ensure that the work piece is a minimum of 12mm (7/16 in.) thick. If it is not, then use a piece of steel plate at least 12mm thick and larger than the magnet, below the work piece, to supplement the magnetic adhesion.** The magnet's adhesion depends on the thickness of the work piece.
- d. **Do not operate the machine on a workpiece while it is being welded.** This may lead to damage to the machine and/or personal injury.
- e. **Never position machine on a work piece between the electrode and the ground of any arc type welder.** The welder's current will ground through the earth wire in the machine's power supply cable, causing it damage.
- f. **Do not exceed 90 degrees from horizontal.** It is hazardous to use the drill upside-down.
- g. **Always ensure that the magnet is clean and free of rust and scale.** Metal chips and other debris will hamper magnetic adhesion.
- h. **Always use the tool alone on the receptacle.** Other units used on the same receptacle could cause uneven voltage that could lead to the magnet releasing.
- i. **Ensure that the magnet has properly adhered to the work piece before beginning drilling.** Proper magnet adhesion is essential for safe drilling.
- j. **When drilling non-ferrous (non-magnetic) work materials, only use a manufacturer-approved fixture such as a vacuum base adapter.** Use of accessories which are not manufacturer-approved could result in a hazardous situation.
- k. **Do not operate with dull or damaged cutting tools.** This may overload the motor.
- l. **Avoid operating annular cutters without cutting fluid.** Always check fluid level before operating. Annular cutters require cutting fluid for proper operation and long life.
- m. **Protect the motor. Never allow cutting fluid, water, or other contaminants to enter the motor.** This could lead to electric shock or motor damage.
- n. **When drilling stacked work materials, always stop to clear the slug after the first layer is drilled.** The loose slug will interfere with proper drilling.
- o. **CAUTION: Never attempt to use machine with incorrect current or abnormally low voltage.** Incorrect voltage could lead to motor damage.
- p. **This machine is not intended for production-line type use.**

## MAGNET BASE DUTY CYCLE

Do not leave the magnet base activated continuously for more than 60 minutes. If the magnet base is overheated, allow it to cool for 30 minutes before continuing.

**CAUTION: Turn the magnet base off when not in use. Leaving the magnet base on continuously will damage it.**

## ASSEMBLY

**Coolant tank assembly required.** First attach clear tube to the bottom of the coolant tank. To do this, first loosen the nut and slide nut onto the tube. Then slide tube onto the nipple. Then tighten the nut. Slide tank hanger over the screw on the upper right hand side of slide and tighten. Finally insert the other end of the tube into the quick-release connector in the gearbox. Just directly push in to install. **(To remove, first firmly push the red collar of the connector and pull the tube out.)** Cutting coolant fluid is always required when using annular cutters. Open tank cover and fill. Check coolant fluid level often. Keep coolant tap closed when not in use.

**Chip guard must be used.** To attach the chip guard, use the supplied butterfly bolts to bolt to the magnet. It is not necessary to remove guard to clean chips. Simply raise guard to its upper position.

**Safety Strap must be used.** Loop strap around the workpiece, feed strap through the power tool's handle, and tighten strap using the ratchet mechanism.

## MOUNTING ANNULAR CUTTERS

**CAUTION: Never use a cutting tool that is larger than the maximum rated capacity of the machine.**

1. To insert an annular cutter, first insert the pilot pin into the cutter. Then slide the cutter into the arbor, align the proper flat with the locking screw(s) and tighten securely with the supplied hex wrench.

**CAUTION: Ensure that the locking screw is on a flat of the cutter and not just against the rounded shank.**

2. Ensure that the oil feed tap is on and coolant feeds properly by pushing the pilot pin. If it feeds too quickly or slowly, adjust the tap accordingly. Keep the tap closed when not in use.

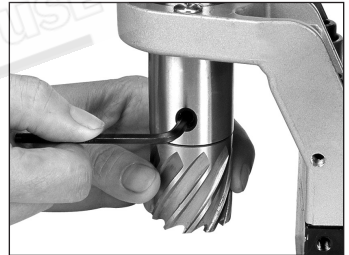

## OPERATION-GENERAL

**WARNING: Always ensure that the magnet is adhered properly to the work piece before beginning drilling.**

**NOTE: If mounting to a curved surface beam, mount the machine parallel to the curve in the work piece.**

**WARNING: Avoid operating at more than 90 degrees from horizontal. When drilling at such an angle take precautions to prevent cutting coolant from entering the motor. Paste-type coolant should be used.**

1. First fit tool into arbor and line up with intended center of cut. Then switch magnet on.

2. Press green motor on button to start motor. Use the crank handle to feed to work. Always use very light pressure when beginning the cut and just as the tool is breaking through. The crank handle offers tremendous leverage; so do not use too much force. Allow the cutting tool to determine the pace. With experience, the operator will be able to determine the best pace to feed to the work. There should be some degree of audible slowing of the motor but not bogging in the cut. Correct cutting speed with a properly sharp annular cutter will produce long unbroken chips, which produce a "bird's" nest shaped bundle of chips around the cut.



**NOTE: Always ensure that the cutting tool is sharp. A dull cutter typically will have finer and/or choppy shavings.**

**WARNING: ALWAYS clear chips when there is too much build-up. Excessive chip build-up could result in a jammed cutter or other hazardous situation.**

**WARNING: the slug ejects at end of cut and is very hot. Always provide a method of catching the slug, where the ejected slug may cause injury to people below.**

**Note: Lock the slide lock on the side of the machine in the fully raised position when at rest to prevent the slide from accidentally slamming down - remember to unlock it again before commencing drilling.**

**CAUTION: Never attempt to cut half-circles or to stitch drill (drill overlapping holes) with a TCT cutter. This may destroy the cutter.**

**CAUTION: Never attempt to re enter a half-finished cut if the magnet has been turned off and the machine shifted in the interim. This may destroy the cutter.**

## TWIST DRILLING

If twist drilling is desired, the arbor support bracket must be removed by removing the three socket-head bolts. Then an optional chuck adaptor arbor and chuck must be fitted. Follow the special instructions below to replace the arbor support bracket.

### Arbor support bracket replacement

1. Replace arbor support bracket and screw in the 3 hex head bolts finger tight only (ensure that the needle bearing is clean and adequately greased.)
2. Replace the annular cutter arbor.

**WARNING: use extreme care to avoid contacting the rotating arbor shaft!**

3. Double check to ensure that there is no binding anywhere throughout the stroke.
4. Tighten the 3 bolts.



## INSTRUCTIONS FOR AUTO-FEED MODELS

**WARNING: NEVER attempt to use machine in auto feed mode when using twist drills. THIS WILL RESULT IN MAGNET LIFTING.**

**WARNING: NEVER use poor quality, incorrect sized or dull cutters in auto feed mode. THIS MAY RESULT IN MAGNET LIFTING.**

### The Auto-Feed Feature

A lever incorporated into the feed handle engages or disengages the feed drive gears. If the auto-feed mode is not engaged, the machine may be used in the same fashion as the manual machine as described above. Below are the additional instructions needed to operate in auto-mode.

**IMPORTANT: When in manual mode, the three lever handles will be pointing outward slightly (out). When in auto-feed mode, the lever handles will be parallel with the side of the machine (in).**

**NOTE: Do not operate the auto machine banked to one side in the plane of the lever as this may allow the machine to slip into or out of auto-feed mode unexpectedly.**

**WARNING: Do not attempt to drill a work piece which is thicker than the maximum cutting depth of the cutter being used. Never exceed 30mm diameter cutters when using auto-feed mode.**

### THE FEED RANGE SELECTOR

There is a 3-position range selector switch on the switch panel which allows ideal feed rate for various sized cutters. Select the feed range which corresponds to the cutter diameter being used.

POSITION	RANGE
1	14~20mm
2	21~24mm
3	25~30mm

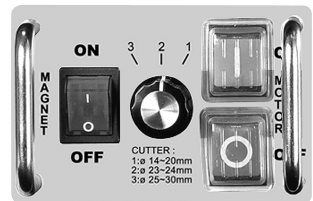

### AUTO-FEED OPERATION

1. Always begin drilling manually (with the handles pointing out) as described above in "OPERATION-GENERAL".
2. Only after the cutter has begun cutting for a few seconds and has raised a chip should the auto feed be engaged.

**NOTE: Do not cut manually for more than 10 seconds before shifting into auto feed. If manual cutting continues for more than 10 seconds, as soon as auto feed is engaged, rather than cutting, it will directly stop.**

3. To engage auto-feed, push any of the lever handles in. The gears may not always line up perfectly. If the

handle will not push in, simply raise the feed upward slightly and the lever will engage.

4. As a precaution, always keep one hand near to the motor shut off switch in order to shut off quickly in the event of any problem.
5. Once the hole is drilled, the machine will continue to feed for 3 seconds (to fully finish hole) and then will automatically shut off.



**NOTE: This machine is equipped with safety override systems which will automatically engage: If the load exceeds maximum for 2 seconds or more, the motor and feed will stop and stay in that position. Only the magnet will stay on. This will alert the operator of an overload problem. If this happens repeatedly, stop operation and find the cause of the excessive load. It could be a bad cutter or other problem.**

**WARNING: WHENEVER THE MACHINE STOPS DUE TO OVERLOAD IN THIS WAY, RAISE THE CUTTER CLEAR OF THE WORKPIECE BEFORE RESTARTING**

**NOTE: when drilling very deep holes with long reach cutters, there is considerable build up of chips. This may interfere with operation and even cause the machine to stop from overload. In this situation, we recommend stopping to clear the chips after the first 25mm (1 inch) or so, then continuing to finish the cut.**

**45mm IS THE MAXIMUM DEPTH OF CUTTING WITH AUTO FEED.**

**NOTE: the maximum rated thickness of material with the auto feed function is 45mm. For drilling thickness up to 50mm, finish by hand feed.**

**WARNING: PAY ATTENTION TO THE CONDITION OF THE CUTTER. This is particularly important with an auto feed machine. A dull or damaged cutter may cause a dangerous situation.**

**WARNING: NEVER ATTEMPT TO DRILL MATERIAL THICKER THAN THE DEPTH CAPACITY OF THE CUTTER. If the cutter is allowed to “bottom out” the feed system may cause the magnet to lift (usually it will overload first).NOTE: In very light load conditions, such as when using very small cutters or drilling a very thin work piece, often the load drop will not be enough to signal the machine’s electronic control board to automatically stop. If this occurs, it does not indicate a malfunction.**

## **SPECIAL INSTRUCTIONS FOR 4-SPEED MT3 EQUIPPED MODELS**

### **CHANGING TOOLS & ADAPTORS WITH MT3 SHANK**

To insert a tool, turn the tool until the tang lines up and firmly push into place. It is helpful to tap with a soft-faced mallet to fully engage the taper. If it is properly in position, one will not be able to pull it back apart by hand. To remove, line up the ejector slot of the arbor with the ejector port in the gear case, slide the ejector drift into the slot and tap with a hammer to eject the tool.

**CAUTION: When removing, take care that the cutting tool does not crash down and get damaged or injure anyone below.**

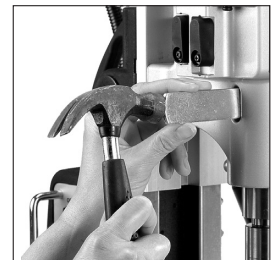

## MT3 ANNULAR CUTTER ADAPTOR

This machine is equipped with a unique annular cutter adaptor system with built-in coolant directly to the gearbox. No stop bar is needed.

1. To install the annular cutter adaptor, first insert the taper end of the adaptor into the arbor of the machine as described above.
2. Attach the coolant tank to the slide and ensure that the tube is attached properly.
3. To insert an annular cutter, first insert the pilot pin. Then slide the cutter into the adaptor, align the proper flat with the locking screw(s) and tighten securely with the supplied hex wrench.
4. Ensure that the oil feed tap is on and coolant feeds properly by pushing the pilot pin. If it feeds too quickly or slowly, adjust the tap accordingly. Keep the tap closed when not in use.

## OPERATION

The operation instructions under "OPERATION-GENERAL" also apply to this machine. Please see the additional instructions specific to the 4-speed Morse taper model below:

**WARNING: NEVER operate 60mm (2-3/8 in.) or larger cutters unless the plate thickness is minimum 20mm (13/16 in.) MAGNET LIFTING MAY RESULT. If the plate thickness is not enough, supplement the magnetic adhesion by adding a 10mm or thicker plate directly the magnet's position under the work piece.**

**CAUTION: Machine is equipped with a reversing switch. Always ensure that direction of rotation is correct before operating. Operating in the wrong direction could result in damage to the cutter.**

Select desired gear range by first popping the tab out of its detent and then sliding selectors up or down in the proper combination. Refer to the chart to achieve the correct combination for the desired speed. (It may be necessary to turn the arbor slightly in order for the gears to mesh properly). Follow the recommended speed ranges on the cutting speed chart to set the proper speed and gear range.

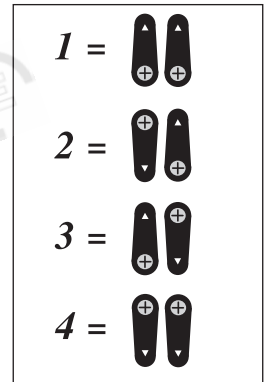

## 4 SPEED GEAR CHART

GEAR	NO LOAD min <sup>-1</sup>	FULL LOAD min <sup>-1</sup>	CUTTERS	TAPS
1	150	90	60~75mm (2-3/8 to 3 in.)	15~25.4mm or less (9/16 to 1 in.)
2	200	120	45~60mm (1-3/4 to 2-3/8 in.)	N/A
3	300	180	35~45mm (1-3/8 to 1-3/4 in.)	N/A
4	380	230	35mm or less (1-3/8 in.)	N/A



**NOTE:** These speeds are general recommendations only. The material should determine actual speeds and the cutting speed recommended by the cutting tool manufacturer. See the section below "RECOMMENDED SURFACE SPEEDS" and use the formula to calculate the best RPM.

**NOTE:** the left and right side gear selectors have a different engagement design:  
**For The LEFT HAND SLIDER must ALWAYS ensure that the machine is FULLY STOPPED before attempting to change gears! NEVER change the Left hand slider gears on a running machine!**  
**For the RIGHT HAND SLIDER the gears select by engagement dogs, similar to a motorcycle transmission design. These MUST BE SELECTED BY TURNING THE ARBOR to allow the dogs to engage.**

**CAUTION:** Ensure that that gears engage fully.

## AVOID OVERHEATING THE MOTOR

When using the machine at or near maximum capacity with a slow motor speed the motor will be at maximum stress and very hot. After each cut is finished, **ALWAYS** cool the motor by running at no load at the maximum motor speed for a few minutes.

## CUTTING SPEEDS

The type of material to be drilled, its hardness and thickness will all greatly affect the recommended cutting speed. See the chart below for general guidelines for cutting speeds. Use the formula to determine the recommended RPM for the diameter of annular cutter being used:

## RECOMMENDED SURFACE SPEEDS

**Note:** work materials which have been flame cut will be heat treated in the affected area. These areas will require much slower cutting speeds.

Work Material	Surface Speed MPM (m/min)
Aluminum	60-90
Brass	40-50
Soft Cast Iron	30-50
Hard Cast Iron	15-21
Mild Steel	24-30
High Tensile Steel	6~13
Stainless Steel	3~5

**RPM = 318.5 x MPM / cutter diameter (in mm)**

**For example:** if you are drilling mild steel with a 50mm cutter, the recommended MPM would be about 30 m/min, so the ideal RPM would be:

$$318.5 \times 30 / 50 = 191 / \text{min}$$

But if you were drilling high tensile steel, the MPM would be about 6 m/min, so the ideal RPM would be:  $318.5 \times 6 / 50 = 38 / \text{min}$

## REVERSING SWITCH

Select desired direction of rotation. This switch has 3 positions: up is forward, middle is neutral, and down is reverse rotation.

**WARNING: If the motor is switched on with the direction switch in the neutral position, the machine will not turn but will be “live”, as soon as either forward or reverse is selected, the arbor will begin turning! Take due care .**



## SAFETY CLUTCH

The 4 speed variable motor speed models are equipped with a safety clutch which is designed to slip when the maximum torque value is exceeded. This clutch is not a tapping clutch and bottoming taps in blind hole is to be avoided.

## TWIST DRILLING

If twist drilling is desired, the arbor support bracket must be removed by removing the three socket-head bolts. Then an MT3 twist drill or an optional chuck adaptor arbor and chuck may be fitted. Follow the special instructions below to replace the arbor support bracket.



**NOTE: A pilot hole may be necessary when drilling with larger twist drills.**

## ARBOR SUPPORT BRACKET REPLACEMENT

1. Replace arbor support bracket and screw in the 3 hex head bolts finger tight only (ensure that the needle bearing is clean and adequately greased.)
2. Replace the annular cutter arbor and carefully tighten the bolts evenly to ensure proper alignment.

**WARNING: use extreme care to avoid contacting the rotating arbor shaft!**

3. Double check to ensure that there is no binding anywhere throughout the stroke.
4. Tighten the 3 bolts.

## CHUCK

If a MT3 chuck adaptor & chuck are used, then the bracket must be removed.

To replace, see the instructions above under “ARBOR SUPPORT BRACKET REPLACEMENT”.

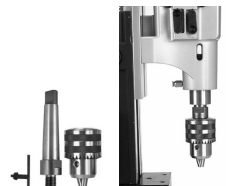

## TAPPING

**CAUTION: To avoid damage to the tap, always very carefully line the tap up with the hole and ensure that the size of the hole is correct for the tap to be used.**

**CAUTION: To avoid damage to the tap or machine, be very careful to stop the machine in time to NOT allow the tap bottom out. The motor continues to coast for a while after being shut off, so plan for this and anticipate. This machine does NOT have a tapping clutch.**

**CAUTION: To avoid damage to the machine, ALWAYS allow the machine to come to a full stop before reversing rotation.**

1. Select the proper speed according to the chart for the size of tap used.
2. Begin with forward direction of rotation with standard right hand threads. (Opposite with left-hand threads)
3. Allow the tap to determine the feed rate. A light touch on the feed handle is all that is needed once it is started in the hole.4. When the desired thread is tapped, hit the red motor stop switch. Allow the machine to come to a full stop. Then reverse direction and restart machine by pressing the green motor switch to remove tap. Guide the tap back out with the feed handle. Proper order of operations for normal tapping is as follows: **magnet: on. direction: forward. motor: on. motor: off. THEN: direction: reverse. motor: on. motor: off - magnet: off.**



## MAINTENANCE

Every 50 hours of operation blow compressed air through the motor while running at no load to clean out accumulated dust. (If operating in especially dusty conditions, perform this operation more often.)

1. Keep the machine clean and free of chips.
2. Check for loose fittings and tighten as needed.
3. Ensure that the ventilation slots are clear so that motor can be cooled normally. Blow low-pressure compressed air through the ventilation slots with the motor running to keep motor clean.

## THE ARBOR SHAFT

Keep the arbor shaft free of dirt and lightly grease as needed. If the arbor support bearing is noisy, it may be dirty or have a chip lodged in it. Remove the arbor shaft to clean and re-grease the arbor support bearing.

## THE GIBS (DOVETAIL SLIDES)

The gibes require adjustment if too loose. To adjust, loosen the lock nuts and adjust the adjuster screws evenly while moving the handle up and down. Adjust so that there is no free play, yet any binding anywhere in its range of travel. Then retighten the lock nuts. Periodically check, lubricate, and adjust as needed.

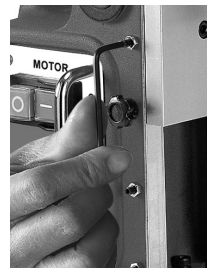

## THE CARBON BRUSHES

The carbon brushes are a normal wearing part and must be replaced when they reach their wear limit.

**Caution: Always replace the brushes as a pair.**

### To replace:

1. Remove the 4 screws and remove the motor tail cover.
2. Using pliers rotate the brush spring out of the way and slide the old carbon brush out of the brush holder.
3. Unscrew the screw to remove the brush lead. The old carbon brush may now be lifted away.
4. Install a new brush. Installation is the reverse of removal.
5. Replace the motor tail cover.

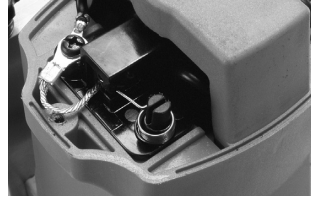

## AUTO STOP CARBON BRUSH

Due to the new auto stop carbon brush if the machine comes to a stop without any reason, the brushes have to be checked. The auto feature stops the machine before the carbon brushes are finished and protects the motor.

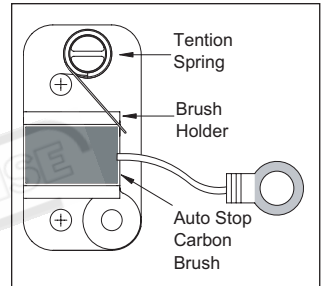

## MAGNET TROUBLESHOOTING

Full magnet performance is absolutely essential for magnetic drill operation.

If the magnet works, but does not hold well, it is likely that one of the coils has failed. If the magnet does not work at all, it is likely to be a failed rectifier. (It is highly unlikely that both magnet coils would fail at the same time)

**NOTE: A faulty magnet coil can also damage the rectifier, so whenever there is a magnet problem, BOTH the magnet coils and rectifier must be checked.**

**WARNING: Never attempt to operate a magnetic drill with a faulty magnet!**

## CHECKING THE MAGNET (qualified technicians only)

If the magnet is not working well, it must be checked. Separate the wires of each individual coil and test the resistance of each coil separately. (note that 110V models are wired in parallel and 230V models are wired in series) The resistance of the coils of different sizes of magnets varies, but it should be in the region of hundreds of ohms. Most importantly, both coils must have very nearly the same resistance. If one of the coils has zero resistance, it means that it is shorted. If one of the coils has infinite resistance, it means that the circuit is broken. If either coil has a problem, the magnet must be replaced. A faulty magnet may also cause damage to the rectifier. Also check the rectifier when replacing a faulty magnet. (see below)

## **CHECKING THE RECTIFIER (Qualified technicians only)**

The rectifier takes the AC household current and converts it to DC to power the magnet. If it fails, the magnet coils will not receive power.

Disconnect the rectifier and test the resistance of both circuits of the rectifier between the AC and the DC sides. Note that polarity matters, so you can only take a reading if test probes are oriented correctly. Each side will be the opposite of the other. Both circuits should have very nearly the same resistance reading. If one of the circuits has zero resistance, it means that it is shorted. If one of the circuits has infinite resistance, it means that the circuit is broken.

**If the replacement of the power supply cord is necessary, this has to be done by the manufacturer or their agent in order to avoid a safety hazard.**

**WARNING: All repairs must be entrusted to an authorized service center. Incorrectly performed repairs could lead to injury or death.**



# HF-35(D950) 1 Speed Drilling System Exploded View & Parts list (N)

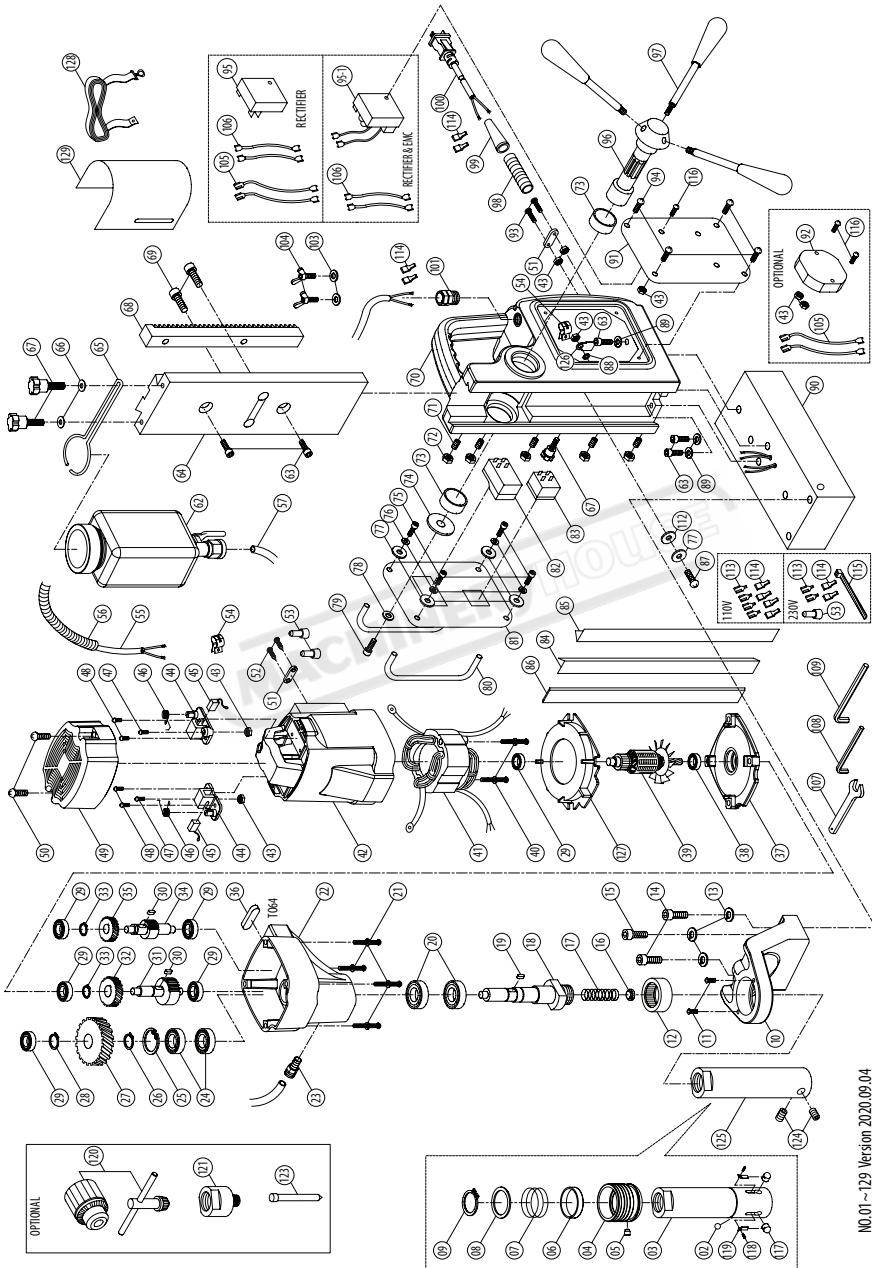

NO.01-129 Version 2020.09.04

NO.	Parts Name	QTY	69	SOCKET CAP SCREW (M8x16xP1.25)	2
1	N/A	-	70	STAND BODY	1
2	CHECK BALL (Ø8)	1	71	SOCKET SET SCREW (M5x20xP0.8)	5
3	QUICK RELEASE ARBOR SHAFT (M27-122.5L)	1	72	HEX NUT (M5xP0.8)	5
4	QUICK-RELEASE COLLAR	1	73	BUSHING (Ø28xØ32x12)	2
5	COLLAR PIN (Ø8)	1	74	FLAT WASHER (Ø6xØ40x2.5)	1
6	RING (Ø40xØ44x9)	1	75	SOCKET CAP SCREW (M4x16xP0.7)	4
7	SPRING (Ø2.3xØ39xØ43.6x3T1x30L)	1	76	SPRING WASHER (M4)	4
8	SPRING SEAT RING (Ø35.1xØ44.5x2)	1	77	FLAT WASHER (Ø4xØ10x1)	5
9	EXTERNAL CIRCLIP (S-35)	1	78	FLAT WASHER (Ø6xØ25x1)	1
10	ARBOR SUPPORT BRACKET	1	79	SOCKET CAP SCREW (M6x16xP1.0)	1
11	TRUSS HEAD MACHINE SCREW (M5x8xP0.8)	2	80	SWITCH GUARD BAR (90MM)	2
12	NEEDLE BEARING (HK 3516)	1	81	SWITCH PANEL (90x110x1.5T)	1
13	SPRING WASHER (M8)	3	82	MOTOR SWITCH (110V/220V)	1
14	SOCKET CAP SCREW (M8x55xP1.25)	2	83	MAGNET SWITCH (110V&220V)	1
15	SOCKET CAP SCREW (M8x30xP1.25)	1	84	GIB STRIP-LEFT (258MM)	1
16	WATER SEAL (Ø16x16)	1	85	GIB STRIP-RIGHT (258MM)	1
17	SPRING (Ø1.5xØ13.3xØ16.3x16T1x140L)	1	86	GIB TENSIONER (258x11x1.2T)	1
18	SPINDLE (M27-121MM)	1	87	PANHEAD MACHINE SCREW (M4x16xP0.7)	1
19	PARALLEL KEY (5x5x10)	1	88	EXTERNAL STAR WASHER (M5)	1
20	OIL SEAL (Ø28xØ40x7)	2	89	SPRING WASHER (M6)	3
21	PANHEAD TAPPING SCREW (M5x70)	4	90	ELECTROMAGNET (164x80x48)	1
22	GEAR HOUSING	1	91	SIDE PANEL (110x90x1.5T)	1
23	PUSH LOCK FITTING (PT1/8"xØ6)	1	92	OVER LOAD PROTECTION (110V-220V)	1
24	BALL BEARING (6003)	2	93	PANHEAD MACHINE SCREW (M4x30xP0.7)	2
25	INTERNAL CIRCLIP (R-35)	1	94	PANHEAD MACHINE SCREW (M4x8xP0.7)	4
26	EXTERNAL CIRCLIP (S-17)	1	95	RECTIFIER (110&220V)	1
27	OUTPUT GEAR (M1.25x3T)	1	95-1	RECTIFIER & EMC (110V&220V)	1
28	EXTERNAL CIRCLIP (S-15)	1	96	CRANK SPINDLE (Ø28)	1
29	BALL BEARING (608)	6	97	CRANK HANDLE	3
30	PARALLEL KEY (4x4x8)	2	98	CABLE PROTECTOR (5/16"x7CM)	1
31	COUNTERSHAFT (M1.25x12T)	1	99	CORD ARMOR	1
32	LAY GEAR (M1.0x34T)	1	100	POWER SUPPLY CABLE	1
33	EXTERNAL CIRCLIP (S10)	2	101	CABLE GLAND (5/16")	1
34	INPUT SHAFT (M1.0 x 9T)	1	103	FLAT WASHER (Ø6xØ13x1)	2
35	INPUT GEAR (M1.0x30T)	1	104	BUTTERFLY SCREW (M6x10xP1.0)	2
36	PARALLEL KEY (4x4x30)	1	105	WIRE LEAD (1015-16#18CM)	4
37	GEAR PLATE	1	106	WIRE LEAD (1015-16#18CM)	2
38	BALL BEARING (6001)	1	107	COMBINATION WRENCH (M8)	1
39	ARMATURE (110V-220V-73x42x45)	1	108	HEX KEY (M2.5)	1
40	PANHEAD TAPPING SCREW (M5x60)	2	109	HEX KEY (M4)	1
41	STATOR (110V-220V-73x42x45)	1	110	CHIP GUARD	1
42	MOTOR HOUSING	1	112	RUBBER WASHER (Ø4xØ11x1)	1
43	HEX NUT (M4xP0.7)	8	113	FEMALE SPADE TERMINAL	4
44	CARBON BRUSH HOLDER (7x11)	2	114	SPADE TERMINAL BOOT	8
45	CARBON BRUSH (7x11x17)	2	115	ZIP TIE (2.4x80MM)	1
46	BRUSH SPRING (Ø.35x3x3T)	2	116	PANHEAD MACHINE SCREW (M4x25xP0.7)	3
47	PANHEAD MACHINE SCREW (M4x10xP0.7)	2	117	LOCK PIN (12.3MM/11.7MM)	2
48	PANHEAD TAPPING SCREW (M4x12)	4	118	PANHEAD MACHINE SCREW (M3x4xP0.5)	2
49	MOTOR TAIL CASTING	1	119	LOCK PIN SPRING	2
50	PANHEAD TAPPING SCREW (M4x25)	2	120	CHUCK (1/2")	1
51	CABLE CLIP	2	121	CHUCK ADAPTOR (M27 / 1/2")	1
52	PANHEAD TAPPING SCREW (M4x14)	2	123	PILOT PIN (HSSx7LxØ6.34)	1
53	CRIMP CAP CONNECTOR (C4)	3	123	PILOT PIN (HSSx103LxØ6.34)	1
54	CABLE CLAMP	2	123	PILOT PIN (TCTx90LxØ7.98)	1
55	WIRE (1.25x2Cx6SCM-VCTF)	1	123	PILOT PIN (TCTx90LxØ6.34)	1
56	CABLE PROTECTOR (5/16"x40CM)	1	123	PILOT PIN (TCTx106LxØ6.34)	1
57	TUBE (Ø4xØ6x20CM)	1	123	PILOT PIN (TCTx108LxØ7.98)	1
62	COOLANT TANK ASSEMBLY	1	124	SOCKET SET SCREW (M8x7xP1.25)	2
63	SOCKET CAP SCREW (M6x20xP1.0)	5	125	ARBOR (M27-122.5L)	1
64	SLIDE PLATE (L238MM)	1	126	EARTHING MARKING	1
65	COOLANT TANK BRACKET	1	127	FAN SHROUD	1
66	FLAT WASHER (Ø5xØ12x1)	2	128	SAFETY BELT	1
67	THUMB SCREW (M5x16)	3	129	CHIP GUARD	1
68	GEAR RACK (M1.5x150L)	1			

# HF-30A(D9505) Semi Auto Feed Drilling System (N) Exploded View & Parts list

NO.01 ~ 146 Version 2020.10.05

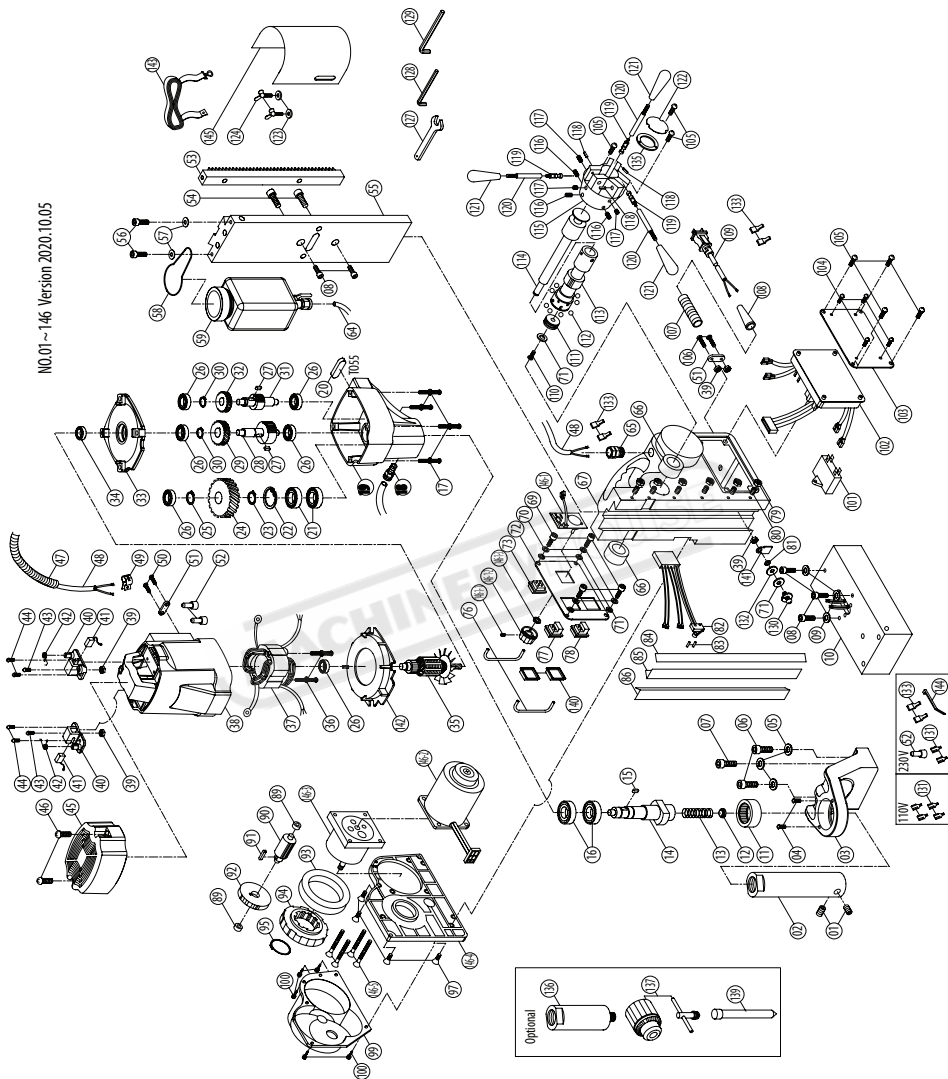



NO.	Parts Name	Q'TY	NO.	Parts Name	Q'TY
1	SOCKET SET SCREW (M8x7xP1.25)	2	81	EXTERNAL STAR WASHER (M5)	1
2	ARBOR (M27-122.5L)	1	82	LIMIT SWITCH (110V&220V)	1
3	ARBOR SUPPORT BRACKET	1	83	PIN	2
4	TRUSS HEAD MACHINE SCREW (M5x8xP0.8)	2	84	GIB TENSIONER (258x11x1.2T)	1
5	SPRING WASHER (M8)	3	85	GIB STRIP-RIGHT (258MM)	1
6	SOCKET CAP SCREW (M8x5xP1.25)	2	86	GIB STRIP-LEFT (258MM)	1
7	SOCKET CAP SCREW (M8x30xP1.25)	1	87	FEED MOTOR	1
8	SOCKET CAP SCREW (M6x20xP1.0)	5	88	FEED MOTOR GEAR BOX	1
9	SPRING WASHER (M6)	3	89	BUSHING (Ø8xØ12x6)	2
10	ELECTROMAGNET (164x80x48)	1	90	FEED INTERMEDIATE GEAR (10T)	1
11	NEEDLE BEARING (HK 3516)	1	91	PARALLEL KEY (4x4x10)	1
12	WATER SEAL (Ø16x16)	1	92	FEED OUTPUT GEAR (80T)	1
13	SPRING (Ø1.5xØ13.3xØ16.3x16Tx140L)	1	93	BALL BEARING (6809)	1
14	SPINDLE (M27-121MM)	1	94	ENGAGEMENT GEAR (63T)	1
15	PARALLEL KEY (5x5x10)	1	95	EXTERNAL CIRCLIP (S-30)	1
16	OIL SEAL (Ø28xØ40x7)	2	96	FEED SUPPORT BASE	1
17	PANHEAD TAPPING SCREW (M5x70)	4	97	FLAT HEAD MACHINE SCREW (M5x15xP0.8)	4
18	PUSH LOCK FITTING (PT1/8"xØ6)	1	98	FLAT HEAD MACHINE SCREW (M5x30xP0.8)	4
19	GEAR HOUSING	1	99	AUTO FEED COVER	1
20	PARALLEL KEY (4x4x30)	1	100	PANHEAD TAPPING SCREW (M5x20)	5
21	BALL BEARING (6003)	2	101	CAPACITOR (110V/220V)	1
22	INTERNAL CIRCLIP (R-35)	1	102	ELECTRONICS BOARD (110V/220V)	1
23	EXTERNAL CIRCLIP (S-17)	1	103	SIDE PANEL (125x82x1.5T)	1
24	OUTPUT GEAR (M1.25x37T)	1	104	PANHEAD TAPPING SCREW (M3.5x6)	4
25	EXTERNAL CIRCLIP (S-15)	1	105	PANHEAD MACHINE SCREW (M4x8xP0.7)	7
26	BALL BEARING (608)	6	106	PANHEAD MACHINE SCREW (M4x30xP0.7)	2
27	PARALLEL KEY (4x4x8)	2	107	CABLE PROTECTOR (5/16"x7CM)	1
28	COUNTERSHAFT (M1.25x12T)	1	108	CORD ARMOR	1
29	LAY GEAR (M1.0x34T)	1	109	POWER SUPPLY CABLE	1
30	EXTERNAL CIRCLIP (S10)	2	110	TRUSS HEAD MACHINE SCREW (M4x10xP0.7)	1
31	INPUT SHAFT (M1.0 x 9T)	1	111	SELECTOR CAM	1
32	INPUT GEAR (M1.0x30T)	1	112	CHECK BALL (Ø5)	8
33	GEAR PLATE	1	113	CRANK SPINDLE (Ø28)	1
34	BALL BEARING (6001)	1	114	SELECTOR ROD	1
35	ARMATURE (110V/220V-73x42x45)	1	115	CRANK HUB	1
36	PANHEAD TAPPING SCREW (M5x60)	2	116	SOCKET SET SCREW (M8x10xP1.25)	3
37	STATOR (110V-220V-73x42x45)	1	117	DETENT UNIT (M6x13xP1.0)	1
38	MOTOR HOUSING	1	118	ROLL PIN (Ø4.2x25)	3
39	HEX NUT (M4xP0.7)	5	119	CRANK LEVER TIP	3
40	CARBON BRUSH HOLDER (7x11)	2	120	CRANK LEVER	3
41	CARBON BRUSH (7x1x1x17)	2	121	CRANK GRIP	3
42	BRUSH SPRING (0.35x3x3T)	2	122	HUB COVER	1
43	PANHEAD MACHINE SCREW (M4x10xP0.7)	2	123	FLAT WASHER (Ø6xØ13x1)	2
44	PANHEAD TAPPING SCREW (M4x12)	4	124	BUTTERFLY SCREW (M6x10xP1.0)	2
45	MOTOR TAIL CASTING	1	125	CHIP GUARD	1
46	PANHEAD TAPPING SCREW (M4x25)	2	127	WRENCH (M8)	1
47	CABLE PROTECTOR (5/16"x40CM)	1	128	HEX KEY (M2.5)	1
48	WIRE (1.25x2CxØ80CM-VCTF)	1	129	HEX KEY (M4)	1
49	CABLE CLAMP	1	130	PANHEAD MACHINE SCREW (M4x16xP0.7)	1
50	PANHEAD TAPPING SCREW (M4x14)	2	131	FEMALE SPADE TERMINAL	4
51	CABLE CLIP	2	132	RUBBER WASHER (Ø4xØ11x1)	1
52	CRIMP CAP CONNECTOR (C4)	3	133	SPADE TERMINAL BOOT	8
53	GEAR RACK (M1.5x150L)	1	134	ZIP TIE (2.4x80MM)	1
54	SOCKET CAP SCREW (M8x16xP1.25)	2	135	HUB PLATE	1
55	SLIDE PLATE (L238MM)	1	136	CHUCK ADAPTOR (M27 / 1/2")	1
56	SOCKET CAP SCREW (M5x16xP0.8)	2	137	CHUCK (1/2")	1
57	FLAT WASHER (Ø5xØ12x1)	2	139	PILOT PIN (HSSx77LxØ6.34)	1
58	COOLANT TANK BRACKET	1	139	PILOT PIN (HSSx103LxØ6.34)	1
59	COOLANT TANK ASSEMBLY	1	139	PILOT PIN (TCTx90LxØ7.98)	1
64	TUBE (Ø4xØ6x20CM)	1	139	PILOT PIN (TCTx90LxØ6.34)	1
65	CABLE GLAND (5/16")	1	139	PILOT PIN (TCTx106LxØ6.34)	1
66	BUSHING (Ø28xØ32x12)	2	139	PILOT PIN (TCTx108LxØ7.98)	1
67	STAND BODY	1	140	SWITCH BOOT	2
68	MAIN SWITCH-3 POSITION (110V&220V)	1	141	EARTHING MARKING	1
69	SOCKET CAP SCREW (M4x16xP0.7)	4	142	FAN SHROUD	1
70	SPRING WASHER (M4)	4	143	SAFETY BELT	1
71	FLAT WASHER (Ø4xØ10x1)	6	144	ZIP TIE (2.5x100MM)	1
72	SWITCH PANEL (125x82x1.5T)	1	145	CHIP GUARD	1
73	MAGNET SWITCH (110V&220V)	1	146	FEED MOTOR	1
76	SWITCH GUARD BAR (64MM)	2	146-1	MAIN SWITCH-3 POSITION (110V&220V)	1
77	MOTOR ON SWITCH (110V&220V)	1	146-2	FEED MOTOR	1
78	MOTOR OFF SWITCH (110V&220V)	1	146-3	FEED MOTOR GEAR BOX	1
79	HEX NUT (M5xP0.8)	6	146-4	FEED SUPPORT BASE	1
80	SOCKET SET SCREW (M5x20xP0.8)	6	146-5	FLAT HEAD MACHINE SCREW (M5x30xP0.8)	4

# HF-750(D9507) 4 Speed Drilling System Exploded View & Parts list

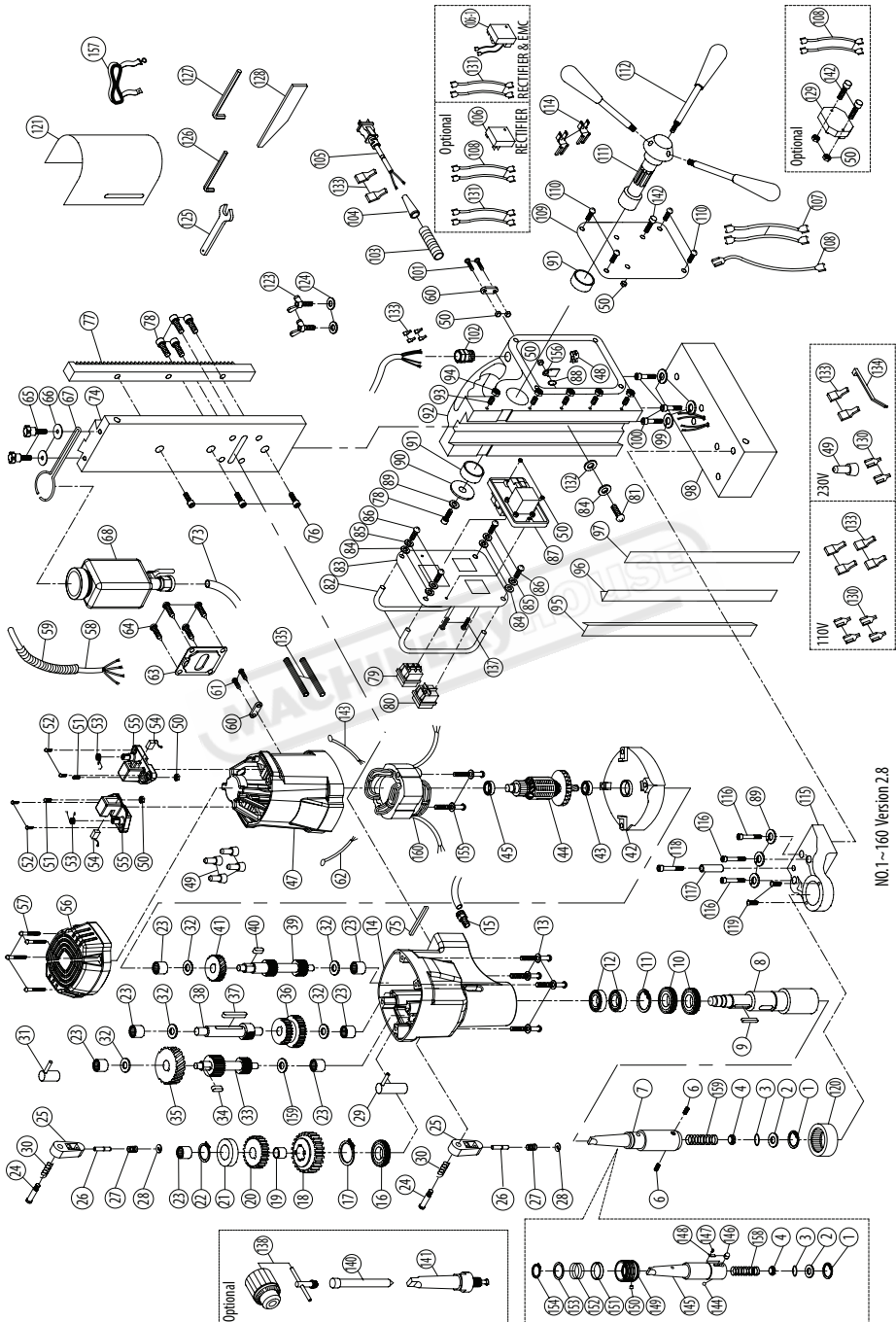

NO.	Parts Name	QTY	83	SWITCH PANEL (130.5x90.5x1.5T)	1
1	INTERNAL CIRCLIP (R-19)	1	84	FLAT WASHER (04x010x1)	5
2	FLAT WASHER (Ø10xØ18.5x0.8)	1	85	SPRING WASHER (M4)	4
3	O-RING (Ø12x4)	1	86	SOCKET CAP SCREW (M4x16xP0.7)	4
4	WATER SEAL (Ø12x15)(WHITE)	1	87	MOTOR SWITCH (110V/220V)	1
5	SPRING (Ø1.2xØ10xØ12.4x241x140L)	1	88	EXTERNAL STAR WASHER (M5)	1
6	SOCKET SET SCREW (M8x7xP1.25)	2	89	SPRING WASHER (M8)	4
7	ARBOR (MT3-Ø19)	1	90	FLAT WASHER (Ø8xØ40x2.5)	1
8	SPINDLE (MT3-199.8MM)	1	91	BUSHING (Ø32xØ38x12)	2
9	PARALLEL KEY (5x5x40)	1	92	STAND BODY	1
10	OIL SEAL (Ø40xØ55x7)	2	93	SOCKET SET SCREW (M5x25xP0.8)	5
11	INTERNAL CIRCLIP (R-55)	1	94	HEX NUT (M5xP0.8)	5
12	BALL BEARING (6006)	2	95	GIB STRIP-LEFT (308MM)	1
13	PANHEAD TAPPING SCREW (M5x65)	4	96	GIB STRIP-RIGHT (308MM)	1
14	GEAR HOUSING	1	97	GIB TENSIONER (308x15x1.2T)	1
15	PUSH LOCK FITTING (PT1/8"x06)	1	98	ELECTROMAGNET (200x100x68)	1
16	OIL SEAL (Ø30xØ45x5)	1	99	SPRING WASHER (M6)	3
17	EXTERNAL CIRCLIP (S-30)	1	100	SOCKET CAP SCREW (M6x20xP1.0)	3
18	LOW SPINDLE GEAR (DP10/12x21T)	1	101	PANHEAD MACHINE SCREW (M4x30xP0.7)	2
19	BUSHING (Ø18xØ20x11.5)	1	102	CABLE GLAND (3/8")	1
20	HIGH SPINDLE GEAR (M1.75x25T)	1	103	CABLE PROTECTOR (5/16"x7CM)	1
21	SPACER (Ø14.2xØ22x5)	1	104	COR ARMOR	1
22	EXTERNAL CIRCLIP (S-14)	1	105	POWER SUPPLY CABLE	1
23	NEEDLE BEARING (HK 1010)	7	106	RECTIFIER (110&220V)	1
24	SHOULDER SCREW	2	106-1	RECTIFIER & EMC (110V)/(110V&220V)	1
25	SELECTOR TAB	2	107	WIRE LEAD (1015-16#9CM)	2
26	DETENT PIN (Ø5x22.5)	2	108	WIRE LEAD (1015-16#18CM)	5
27	SPRING (Ø0.6xØ5.3xØ6.5x17Lx5T)	2	109	SIDE PANEL (130.5x90.5x1.5T)	1
28	E-CLIP (E-3)	2	110	PANHEAD MACHINE SCREW (M4x8xP0.7)	4
29	FIRST SELECTOR FORK (Ø12x26 / Ø4x25)	1	111	CRANK SPINDLE (Ø32)	1
30	SPRING (Ø1xØ9xØ11x1Lx4T)	2	112	CRANK HANDLE	3
31	SECOND SELECTOR FORK (Ø12x21 / Ø4x32.2)	1	114	THREE WIRE PUSH IN CONNECTOR	2
32	THRUST RING (1024)	5	115	ARBOR SUPPORT BRACKET	1
33	IDLER SHAFT (M1.75x161x7T)	1	116	SOCKET CAP SCREW (M8x25xP1.25)	3
34	PARALLEL KEY (5x5x10)	1	117	TRAVEL STOP (Ø6.5xØ12x34)	1
35	IDLER GEAR (M1.75x36T)	1	118	SOCKET CAP SCREW (M6x45xP1.0)	1
36	LAY GEAR (M1.25x28Tx30T)	1	119	TRUSS HEAD MACHINE SCREW (M4x6xP0.7)	2
37	PARALLEL KEY (5x5x50)	1	120	NEEDLE BEARING (HK 3516)	1
38	COUNTERSHAFT (M1.25x12T)	1	121	CHIP GUARD	1
39	INPUT SHAFT (M1.25x12Tx10T)	1	123	BUTTERFLY SCREW (M6x10xP1.0)	2
40	PARALLEL KEY (5x5x8)	1	124	FLAT WASHER (Ø6xØ13x1)	2
41	INPUT GEAR (M1.0x29T)	1	125	WRENCH (M8)	1
42	GEAR PLATE	1	126	HEX KEY (M2.5)	1
43	BALL BEARING (6202)	1	127	HEX KEY (M4)	1
44	ARMATURE (110V/220V-94x54x45)	1	128	DRIFT	1
45	BALL BEARING (6200)	1	129	OVER LOAD PROTECTION (110V/220V)	1
47	MOTOR HOUSING	1	130	FEMALE SPADE TERMINAL	4
48	CABLE CLAMP	1	131	WIRE LEAD (1015-16#18CM)	2
49	CRIMP CAP CONNECTOR (C4)	5	132	RUBBER WASHER (Ø4xØ11x1)	1
50	HEX NUT (M4xP0.7)	10	133	SPADE TERMINAL BOOT	10
51	PANHEAD MACHINE SCREW (M4x10xP0.7)	2	134	ZIP TIE (2.4x100MM)	1
52	PANHEAD TAPPING SCREW (M4x12)	4	135	WIRE SLEEVE (Ø4)	2
53	BRUSH SPRING (0.4x4x3.5T)	2	137	PANHEAD MACHINE SCREW (M4x20xP0.7)	2
54	CARBON BRUSH (7x17x17)	2	138	CHUCK (5/8")	1
55	BRUSH HOLDER (7x17)	2	140	PILOT PIN (H55x77LxØ6.34)/(H55x103LxØ6.34)	1
56	MOTOR TAIL CASTING	1	140	PILOT PIN (TCTx90LxØ7.98)/(TCTx90LxØ6.34)	1
57	PANHEAD TAPPING SCREW (M4x20)	4	140	PILOT PIN (TCTx106LxØ6.34)/(TCTx108LxØ7.98)	1
58	WIRE (2.0x4Cx86CM-5JT)	1	141	CHUCK ADAPTOR (MT3-5/8")	1
59	CABLE PROTECTOR (3/8" x50CM)	1	142	PANHEAD MACHINE SCREW (M4x25xP0.7)	3
60	CABLE CLIP	2	143	WIRE LEAD (1015-16#30CM)	1
61	PANHEAD TAPPING SCREW (M4x16)	2	144	CHECK BALL (Ø8)	1
62	WIRE LEAD (1015-16#26CM)	1	145	QUICK RELEASE ARBOR SHAFT (MT3)	1
63	MOTOR COVER PLATE	1	146	LOCK PIN (12.3MM)/(11.7MM)	1
64	FLAT HEAD TAPPING SCREW (M5x10)	4	147	PANHEAD MACHINE SCREW (M3x4xP0.5)	1
65	THUMB SCREW (M5x16)	2	148	LOCK PIN SPRING	1
66	FLAT WASHER (Ø5xØ12x1)	2	149	QUICK-RELEASE COLLAR	1
67	COOLANT TANK BRACKET	1	150	COLLAR PIN (Ø8)	1
68	COOLANT TANK ASSEMBLY	1	151	RING (Ø40xØ44x9)	1
73	TUBE (Ø4xØ6x30CM)	1	152	SPRING (Ø2.3xØ39xØ43.6x31x30L)	1
74	SLIDE PLATE (L348MM)	1	153	SPRING SEAT RING (Ø35.1xØ44.5x2)	1
75	PARALLEL KEY (4x4x30)	1	154	EXTERNAL CIRCLIP (S-35)	1
76	SOCKET CAP SCREW (M8x20xP1.25)	3	155	PANHEAD TAPPING SCREW (M5x60)	2
77	GEAR RACK (M2.0x270L)	1	156	EARTHING MARKING	1
78	SOCKET CAP SCREW (M8x16xP1.25)	5	157	SAFETY BELT	1
79	REVERSING SWITCH (110V&220V)	1	158	SPRING (Ø1.2xØ10xØ12.4x15Tx100L)	1
80	MAGNET SWITCH (110V&220V)	1	159	THRUST RING (Ø13xØ24x1)	1
81	PANHEAD MACHINE SCREW (M4x16xP0.7)	1	160	STATOR (110V/220V-94x54x45)	1
82	SWITCH GUARD BAR (110MM)	2			

# HF-35(D950) 1 Speed Drilling System (N) Wiring

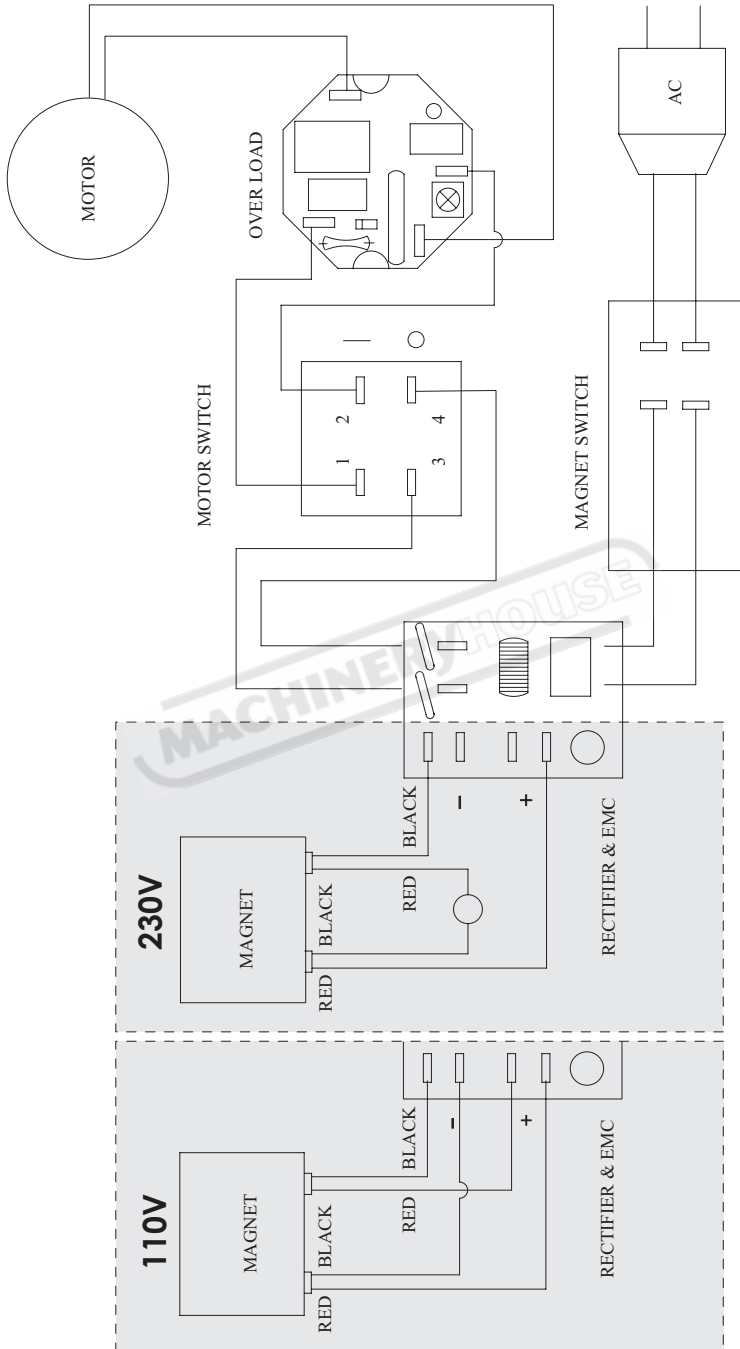

# HF-30A(D9505) Semi Auto Feed Drilling System (N) Wiring

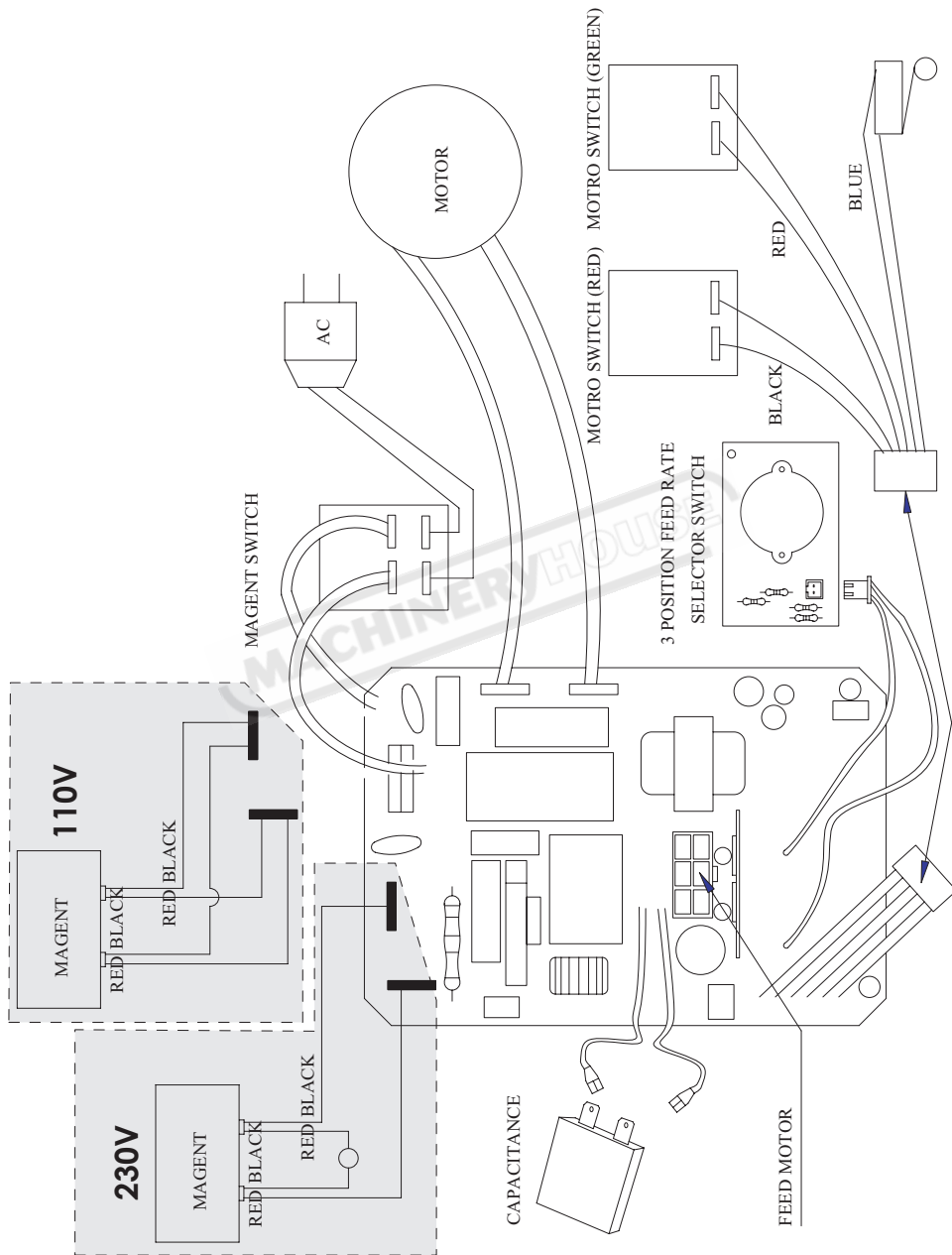

# HF-750(D9507) 4 Speed Drilling System Wiring

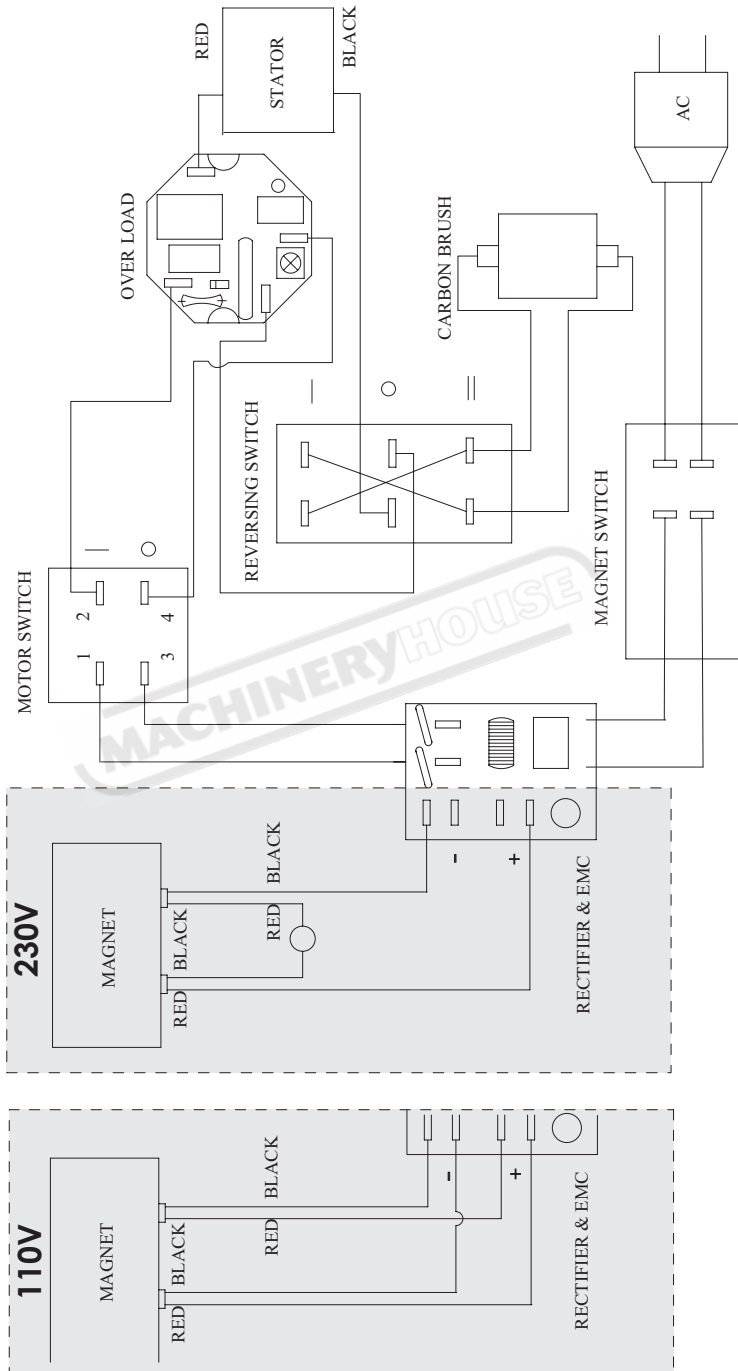

MACHINERYHOUSE

